



# Operating Manual

## (For Wi-Fi App series)

# Table of content

<b>1. INFORMATION ON THIS DOCUMENT .....</b>	<b>4</b>
1.1 VALIDITY .....	4
1.2 TARGET GROUP .....	4
1.3 CONTENT AND STRUCTURE OF THIS DOCUMENT .....	4
1.4 DECLARATION OF CONFORMITY .....	4
1.5 LEVELS OF WARNING MESSAGES.....	5
1.6 SYMBOLS IN THE DOCUMENT .....	5
1.7 DESIGNATION IN THE DOCUMENT .....	5
<b>2. SAFETY.....</b>	<b>6</b>
2.1 INTENDED USE .....	6
2.2 IMPORTANT SAFETY INSTRUCTIONS.....	6
2.2.1 Battery Pack Leakage.....	6
2.2.2 Firefighting Measures.....	7
2.2.3 Battery Packs Handling and Storage Guide .....	7
2.2.4 Warning of Electric Shock .....	8
2.2.5 Warning of Overvoltage .....	8
2.2.6 Caution of Weight .....	8
2.2.7 Notice of Property Damage .....	9
<b>3. SCOPE OF DELIVERY .....</b>	<b>9</b>
<b>4. ENERGY STORAGE SYSTEM OVERVIEW .....</b>	<b>10</b>
4.1 ENERGY STORAGE SYSTEM DESCRIPTION.....	10
4.2 SYMBOL ON THE SYSTEM.....	11
4.3 DISPLAY INTERFACE .....	12
<b>5. INSTALLATION.....</b>	<b>13</b>
5.1 REQUIREMENTS FOR INSTALLATION.....	13
5.1.1 Requirements for Installation Location .....	13
5.1.2 Installation Tools.....	14
5.1.3 Safety Gear .....	15
5.1.4 Additionally Required Installation Material .....	15
5.2 INSTALLATION .....	15
<b>6. ELECTRICAL CONNECTION.....</b>	<b>17</b>
6.1 OVERVIEW OF THE CONNECTION AREA .....	17
6.2 INVERTER CONNECTION AREA VIEW .....	17
6.3 BATTERY PACK CONNECTION AREA VIEW .....	18
6.4 CONNECTION DIAGRAM .....	19
<b>Build-in Inverter Low Voltage System Operating Manual</b>	<b>1</b>

## **CONCENPOWER Co., Ltd.**

6.5 CONNECTING THE GROUNDING CONDUCTOR .....	20
6.6 DIAL CODE INFORMATION.....	21
6.6.1 Battery pack address dial code (Blue dip).....	21
6.6.2 Battery pack working mode code (Red dip).....	22
6.7 COMMUNICATION CABLES CONNECTION.....	22
6.7.1 Between Battery packs (RS485-2 to RS485-2).....	22
6.7.2 Between battery packs and inverter .....	22
6.8 WIRING CONNECTION.....	23
<b>7. COMMISSION .....</b>	<b>25</b>
<b>8. WI-FI APP ACTIVATION (WI-FI APP DEVICES).....</b>	<b>26</b>
<b>9. CLOSE UP .....</b>	<b>31</b>
<b>10. DECOMMISSIONING.....</b>	<b>32</b>
<b>11. EXTENSION.....</b>	<b>33</b>
<b>12. TROUBLESHOOTING.....</b>	<b>34</b>
12.1 ENERGY STORAGE SYSTEM BEHAVIOR UNDER FAULT CONDITIONS.....	34
12.2 INVERTER CANNOT DETECT BATTERY INFORMATION .....	35
12.3 ERROR EVENT .....	35
<b>13. MAINTENANCE AND STORAGE.....</b>	<b>36</b>
<b>14. DISPOSAL OF ENERGY STORAGE SYSTEM .....</b>	<b>37</b>
<b>15. TECHNICAL DATA.....</b>	<b>38</b>
15.1 2.5kWh BATTERY PACK .....	38
15.2 5.12kWh BATTERY PACK .....	40
15.3 10.24kWh BATTERY PACK.....	42
<b>16. CONTACT INFORMATION .....</b>	<b>44</b>

## Legal Provisions

All the information in this document is the property of Shandong King Polaris New Energy Stock CO., LTD. No part of this document could be reproduced in any way for business use. Internal use is allowed.

Shandong King Polaris New Energy Stock CO., LTD makes no representations or warranties express or implied, with respect to this document or any of the equipment and/or software it may describe, including (with no limitation) any implied warranties of utility, merchantability, or fitness for any particular purpose. All such representations or warranties are expressly disclaimed. Neither Shandong King Polaris New Energy Stock CO., LTD nor its distributors or dealers shall be liable for any indirect, incidental, or consequential damages under any circumstances.

The exclusion of implied warranties may not apply in all cases under some statutes, and thus the above exclusion may not apply.

This document does not replace and is not intended to replace any local, state, provincial, federal, or national laws, regulations, or codes applicable to the installation, electrical safety, and use of the energy storage system. Shandong King Polaris New Energy Stock CO., LTD assumes no responsibility for the compliance or noncompliance with such laws or codes in connection with the installation of the energy storage system.

Specifications are subject to change without notice. Every effort has been made to make this document complete, accurate, and up to date. However, Shandong King Polaris New Energy Stock CO., LTD may need to make some improvements under certain circumstances without advance notice. Shandong King Polaris New Energy Stock CO., LTD shall not be responsible for any loss caused CONCENPOWER this document, including, but not limited omissions, errors, typographical errors, arithmetical errors, or listing errors in this document. All trademarks are recognized.

### Limited Warranty

You can download the latest Limited Warranty from the Internet at [www.concenpower.com](http://www.concenpower.com).

Shandong King Polaris New Energy Stock CO., LTD

## 1. Information on this document

### 1.1 Validity

This document is valid for the product of Low Voltage parallel system with build-in inverter, model: 2.5 CON-BILVS, 5 CON-BILVS, 10 CON-BILVS .

### 1.2 Target group

The instructions in this document may only be performed CONCENPOWER qualified persons who must have the following skills:

- Knowledge of how batteries work and are operated
- Knowledge of how an inverter works and is operated
- Knowledge of, and adherence to the locally applicable connection requirements, standards, and directives\*
- Knowledge of, and adherence to this document and the associated system documentation, including all safety instructions
- Training in dealing with the hazards associated with the installation and operation of electrical equipment and batteries
- Training in the installation and commissioning of electrical equipment

Failure to do so will make any manufacturer's warranty, guarantee or liability null, and void unless you can prove that the damage was not due to non-compliance.

### 1.3 Content and structure of this document

This document contains safety information and instructions, scope of delivery, system overview, installation, electrical connection, commissioning, decommissioning, expansion, troubleshooting, maintenance and storage, disposal, and technical data. Please finish reading this document before taking any actions on the energy storage system.

### 1.4 Declaration of Conformity

The energy storage system described in this document complies with the applicable European directives. The certificate is available in the download area at [www.concenpower.com](http://www.concenpower.com).

### 1.5 Levels of Warning Messages

The following levels of warning messages may occur when handling the energy storage system.

**⚠ DANGER**

Indicates a hazardous situation which, if not avoided, will result in death or serious injury.

**⚠ WARNING**

Indicates a hazardous situation which, if not avoided, could result in death or serious injury.

**⚠ CAUTION**

Indicates a hazardous situation which, could result in minor or moderate injury

**NOTE**

Indicates a situation which, if not avoided, can result in property damage.

### 1.6 Symbols in the Document

**⚠ QUALIFIED PERSON**

Sections describing activities to be performed CONCENPOWER qualified persons only.

### 1.7 Designation in the Document

Designation in this document	Complete designation
Energy storage system	CONCENPOWER energy storage system
BMS	Battery management system
SOC	State of charge
Inverter	The build-in inverter of this product
CONCENPOWER	Shandong King Polaris New Energy Stock CO., LTD

## 2. Safety

### 2.1 Intended Use

The energy storage system is for residential and works with a photovoltaic system. It is a high-capacity battery storage system, with the management system on itself. It could be operated in on-grid, off-grid and backup modes with compatible inverters.

The energy storage system must only be used as stationary equipment.

The energy storage system is suitable for indoor and outdoor use under the conditions mentioned in Section 5.1.

The energy storage system is not suitable for supplying life-sustaining medical devices. Please ensure that no personal injury would lead due to the power outage of the energy storage system.

Alterations to the energy storage system, e.g., changes or modifications are not allowed unless the written permission of CONCENPOWER is achieved. Unauthorized alterations will void the guarantee and warranty claims. CONCENPOWER shall not be held liable for any damage caused CONCENPOWER such changes. The type of label should always be attached to the energy storage system.

### 2.2 Important Safety Instructions

The energy storage system has been designed and tested in accordance with international safety requirements. However, in order to prevent personal injury and property damage and ensure long-term operation of the energy storage system, please do read this section carefully and observe all safety information at all times.

#### 2.2.1 Battery Pack Leakage

If the battery packs leak electrolytes, contact with the leaking liquid or gas should be avoided. The electrolyte is corrosive, and the contact may cause skin irritation and chemical burns. If one is exposed to the leaked substance, do these actions:

**Inhalation:** Evacuate the contaminated area and seek medical help immediately.

**Eye contact:** Rinse eyes with flowing water for 15 minutes and seek medical help immediately.

**Skin contact:** Wash the affected area thoroughly with soap and water and seek medical help immediately.

**Ingestion:** Induce vomiting and seek medical help immediately.

## 2.2.2 Firefighting Measures

The battery packs may catch fire when it is put into the fire. In case of a fire, please make sure that an ABC or carbon dioxide extinguisher is nearby. Water cannot be used to extinguish the fire. Full protective clothing and self-contained breathing apparatus are required for the firefighters to extinguish the fire.

Full protective clothing and self-contained breathing apparatus are required for the firefighters to extinguish the fire.

## 2.2.3 Battery Packs Handling and Storage Guide

- The battery packs and its components should be protected from damage when transporting and handling.
- Do not impact, pull, drag, or step on the battery packs.
- Do not insert unrelated objects into any part of the battery packs.
- Do not throw the battery pack into a fire.
- Do not soak the battery packs in water or seawater.
- Do not expose to strong oxidizers.
- Do not short circuit the battery packs.
- The battery packs cannot be stored at high temperatures (more than 50°C).
- The battery packs cannot be stored directly under the sun.
- The battery packs cannot be stored in a high humidity environment. • Do not use the battery packs if it is defective, or appears cracked, broken or otherwise damaged, or fails to operate.
- Do not attempt to open, disassemble, repair, tamper with, or modify the battery packs. The battery packs are not user-serviceable.
- Do not use cleaning solvents to clean the battery packs.

## 2.2.4 Warning of Electric Shock

### DANGER

Danger to life due to electric shock when live components or DC cables are touched. The DC cables connected to an inverter may be live. Touching live DC cables results in death or serious injury due to electric shock.

- Disconnect the energy storage system and inverter from voltage sources and make sure it cannot be reconnected before working on the device.
- Do not touch non-insulated parts or cables.
- Do not remove the terminal block with the connected DC conductors from the slot under load.
- Wear suitable personal protective equipment for all work on the energy storage system.

## 2.2.5 Warning of Overvoltage

### DANGER

Danger to life due to electric shock in case of overvoltages and if surge protection is missing. Overvoltages (e. g. in the event of a flash of lightning) can be further conducted into the building and to other connected devices in the same network via the network cables or other data cables if there is no surge protection. Touching live parts and cables results in death or lethal injuries due to electric shock.

- Ensure that all devices in the same network and the inverter are integrated into the existing surge protection.
- When laying the network cables or other data cables outdoors, it must be ensured that a suitable surge protection device is provided at the transition point of the cable from the energy storage system or the inverter outdoors to the inside of a building.

## 2.2.6 Caution of Weight

### CAUTION

Risk of injury due to weight of the battery pack. Injuries may result if the battery pack is lifted incorrectly or dropped while being transported or installed.

- Transport and lift the battery pack carefully. Take the weight of the battery pack into account.
- Wear suitable personal protective equipment for all work on the energy storage system.

### 2.2.7 Notice of Property Damage

#### NOTE

Damage to the inverter due to sand, dust and moisture ingress Sand, dust and moisture penetration can damage the inverter and impair its functionality.

- Only open the inverter if the humidity is within the thresholds and the environment is free of sand and dust.





#### NOTE

Damage to the energy storage system due to under voltages

- If the energy storage system doesn't start at all, please contact CONCENPOWER local after-sales service within 48 hours. Otherwise, the battery could be permanently damaged.

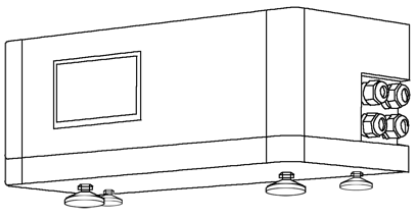
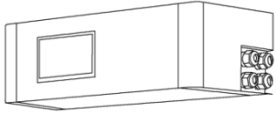
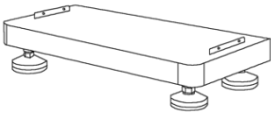



## 3. Scope of Delivery

### Inverter and Base Package

				
	Inverter *1 Pcs	Base *1 Pcs		
				
	M4*14 screw *4 Pcs	Documents *1 Pcs	Wi-Fi receiver nut *1 Pcs	

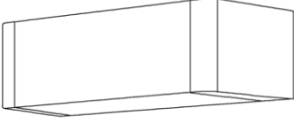
1. **Documents:** include Operating Manual, Quick Start Guide, Service Guideline and Checklist
2. **M4\*14 Countersunk screw:** Screw to fix the connection between packs, base, and inverter
3. **Wi-Fi receiver nut (\* \* limited to APP products):** Install the top of the Wi Fi receiver and keep it exposed in the air for signal reception

**Battery pack Package**

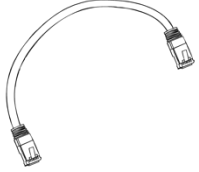
				
Battery pack *1 Pcs	M4*14 Countersunk screw *4 Pcs	Battery pack positive connector *1 Pcs	Battery pack negative connector *1 Pcs	Communication cable *1 Pcs

1. **M4\*14 Countersunk strew:** Screw to fix the connection between packs, base, and inverter
2. **Battery pack positive connector:** For positive connection between battery packs or battery pack and inverter, 30cm
3. **Battery pack negative connector:** For negative connection between battery packs or battery pack and inverter, 30cm
4. **Communication cable:** For communication between battery packs and between battery packs and inverter 30cm, CAT5





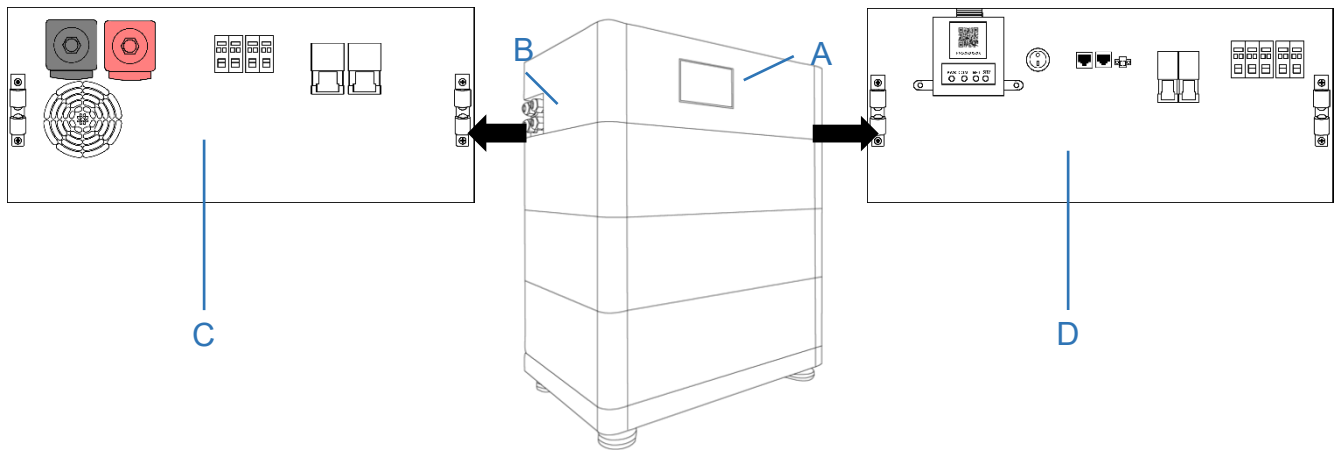



**4. Energy storage system overview**



**4.1 Energy storage system Description**



A	Screen
B	Gland area
C	Input connection area
D	Communication, output connection area

4.2 Symbol on the system

Symbol	Explanation
	<p>Observe the documents Observe all documents supplied with the system</p>
	<p>Grounding conductor This symbol indicates the position for connecting a grounding conductor</p>
	<p>Disposal Do not dispose of the system together with household waste.</p>
	<p>CE marking The system complies with the requirements of the applicable EU directives.</p>
	<p>Place it straight up, without inclination or upside down.</p>
	<p>Handle with care</p>
	<p>Keep it dry</p>
	<p>Keep the battery packs away from open flame or ignition sources.</p>
	<p>Beware of electrical voltage.</p>

	<p>Beware of a danger zone This symbol indicates that the system must be additionally grounded if additional grounding or equipotential bonding is required at the installation site.</p>
	<p>Keep the battery packs away from children.</p>
	<p>Do not short circuit.</p>

### 4.3 Display Interface

Management system operating system instructions

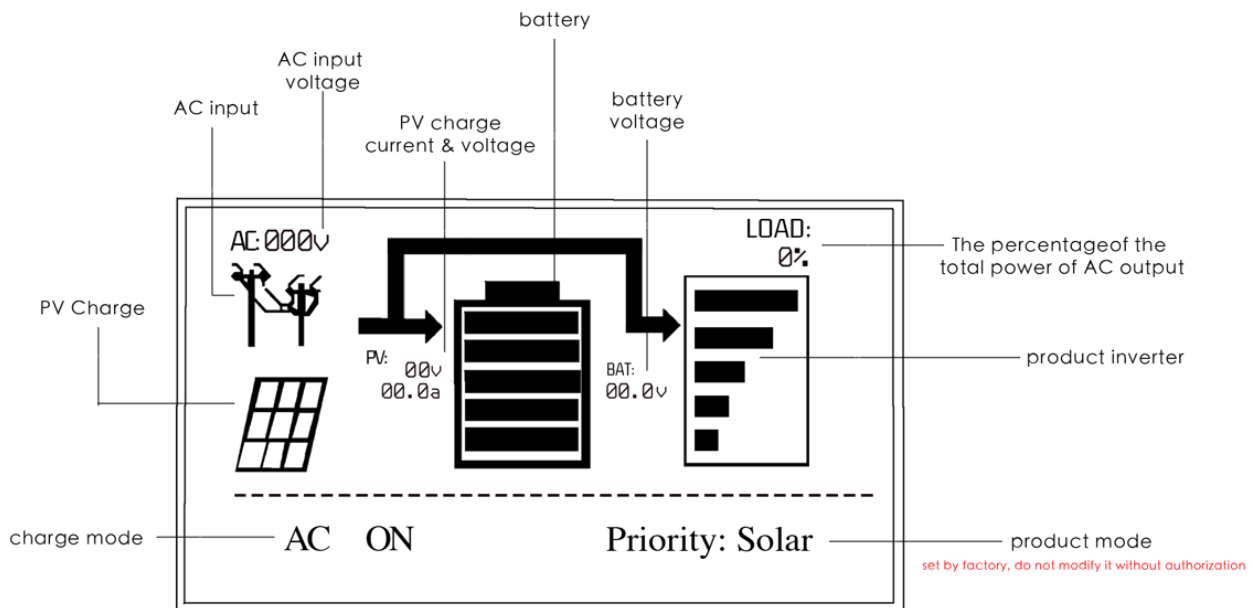

Press the ENTER/CONFIRM button for 3 seconds, enter the setting interface. (The picture shows the factory setting, **WARNING:NO CHANGE ALLOWED!!!**).

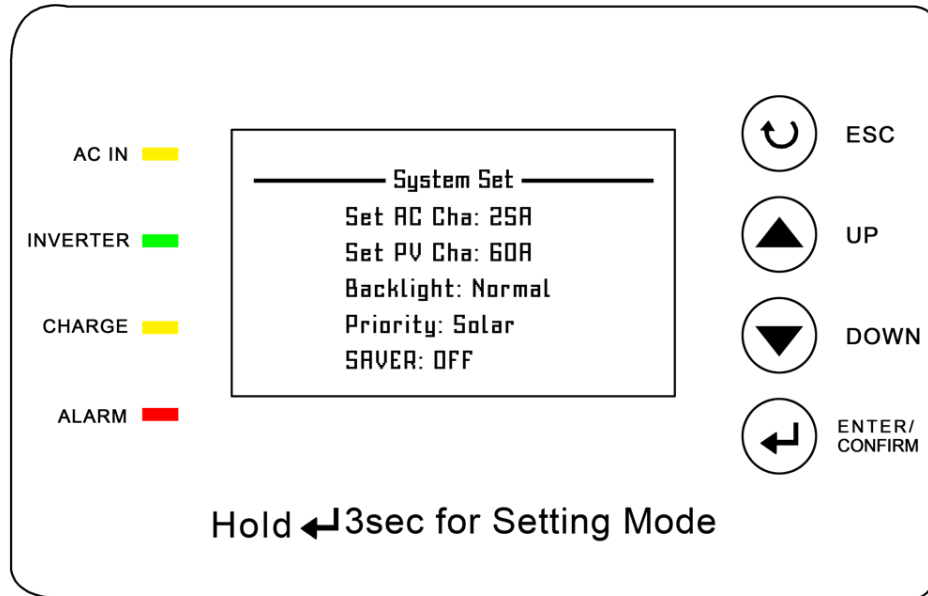

## 5. Installation

### 5.1 Requirements for Installation

#### 5.1.1 Requirements for Installation Location

- A solid support surface must be available (e.g., concrete or masonry).
- The installation location must be inaccessible to children.
- The installation location must be ventilated.
- The installation location must be suitable for the weight and dimensions of the energy storage system.
- The installation location must not be exposed to direct solar irradiation.
- The installation location must not be close to the fire.
- The altitude of the installation location should be less than 3000m.
- The ambient temperature should be between -10°C and +50°C.
- The ambient humidity should be between 5-95%.



Max +50° C



Min -10° C





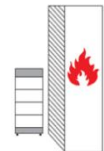

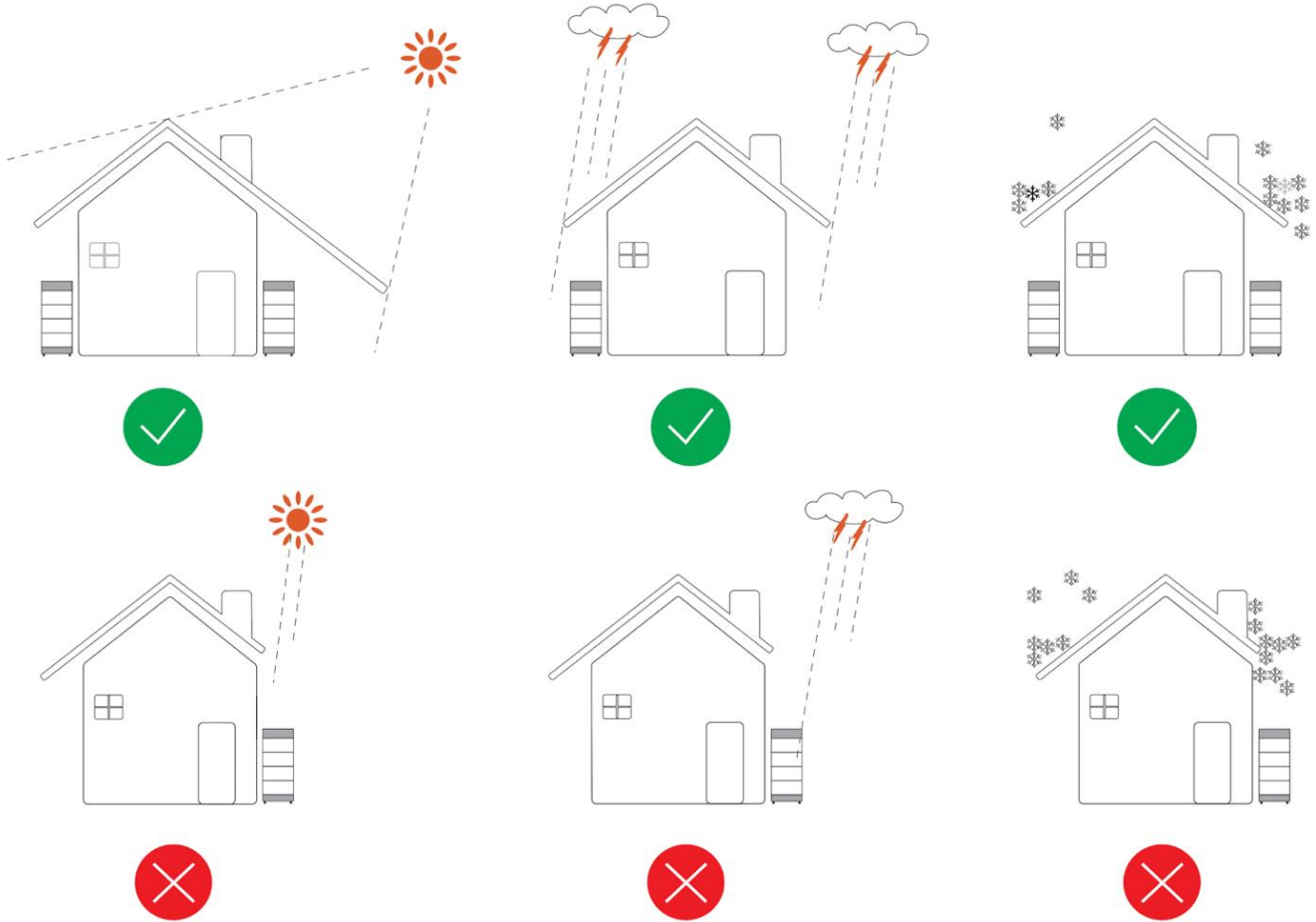



RH. +5% ~ +95%



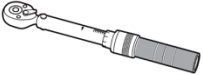
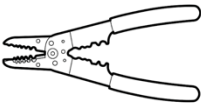
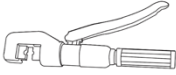

### 5.1.2 Installation Tools

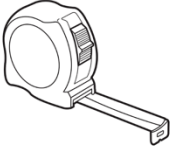
The tools in the following table could be needed during the installation.

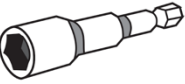
				
Network Wire Clamp	Pen	Phillips Screwdriver Bit	Flat-Head Screwdriver	Torque Wrench
				
Wire Stripper	Crimping Pliers	Wrench	Tape Measure	Drill
				
Hair Dryer	Cylinder Screwdriver			

### 5.1.3 Safety Gear

Wear the following safety gear when dealing with the energy storage system.



Insulated gloves



Safety goggles



Safety shoes

### 5.1.4 Additionally Required Installation Material



x2

K

DC Cable



x2

L

Expansion Anchor Bolt(M8x40)



M

Cat5 Shield

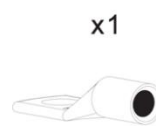

x1

N

PE Terminal

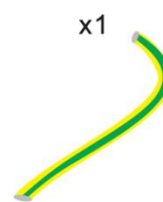

x1

O

PE



x1

P

Heat Shrink Tubing

## 5.2 Installation

### ⚠ QUALIFIED PERSON

### ⚠ DANGER

#### Danger to life from electric shock due to live DC cables or connectors at the energy storage system

The DC cables connected to the energy storage system may be live. Touching the DC conductors or the live components leads to lethal electric shocks.

- Do not touch non-insulated cable ends.

### ⚠ CAUTION

#### Risk of injury due to weight of the battery pack

Injuries may result if the battery pack is lifted incorrectly or dropped while being transported or installed.

- Transport and lift the battery pack carefully. Take the weight of the battery pack into account.
- Wear suitable personal protective equipment for all work on the energy storage system.

**Additionally required installation material (not included in the scope of delivery):**

- Two screws suitable for the support surface (diameter: 8 mm)
- Where necessary, two screw anchors suitable for the support surface and the screws.

**Procedure:**

1. Take the inverter and base from the package out.
2. Remove the covers on both sides of the inverter.
3. Loose the four screws with screwdriver PH2.
4. Take the inverter from the base.

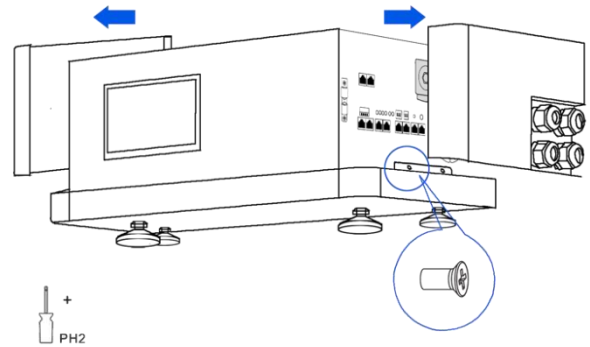

5. Put the installed base and feet along the wall and keep the distance of 10-15cm between the wall and the base.

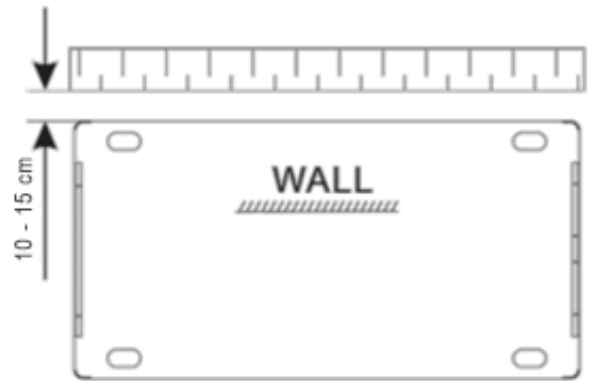

Linear Measure: cm

6. Take a battery pack from the package out. Put one battery pack on the base. Pay attention to the direction of the pack. The positive and negative connectors on the battery pack and the base should be on the same side.
7. Repeat the operations for other battery packs.

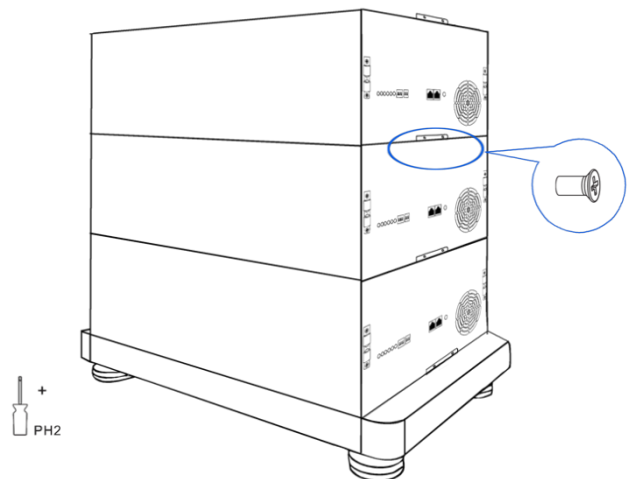

8. Put the inverter on top of the battery packs. Recommend connecting cables on the inverter first when five or more than five battery packs are needed to be installed in one tower.
9. Fix the connection between the battery pack and the base, between battery packs, and between inverter and battery pack. To do this, insert the screws (M4x14) through the holes on them, using a Phillips screwdriver (PH2) and tighten them (torque: 2 Nm).

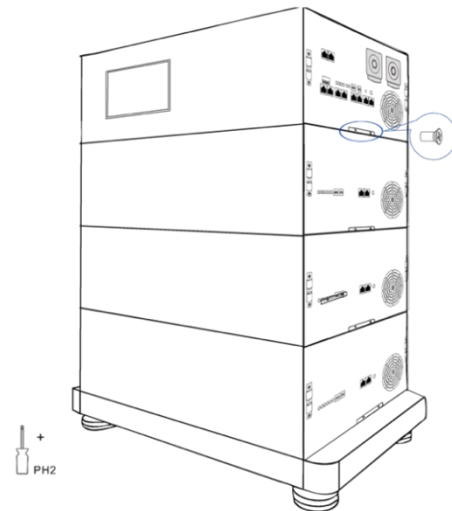

## NOTE

### Damage to the energy storage system due to under voltages

- If the battery is installed, it should be set into operation within a month, or checked regularly, otherwise there might be damage to the batteries.

## 6. Electrical Connection

### 6.1 Overview of the Connection Area

### 6.2 Inverter Connection Area View

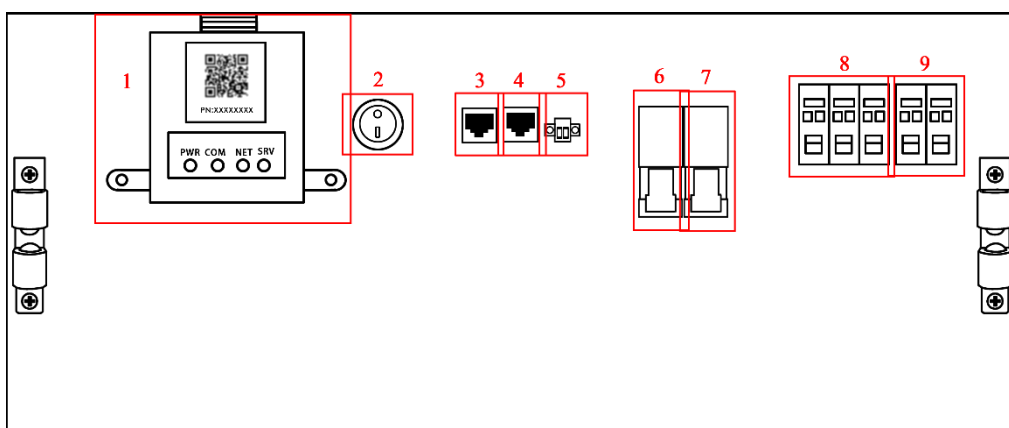

1	Wi-Fi receiver
2	Inverter switch
3	Wi-Fi App communication ports

**CONCENPOWER Co., Ltd.**

4	RS 485 communication ports
5	Generator start stop port
6	AC input air switch
7	AC output air switch
8	AC input connection terminal (From left to right: L, N, G; G is public)
9	AC output connection terminal (From left to right: L, N)

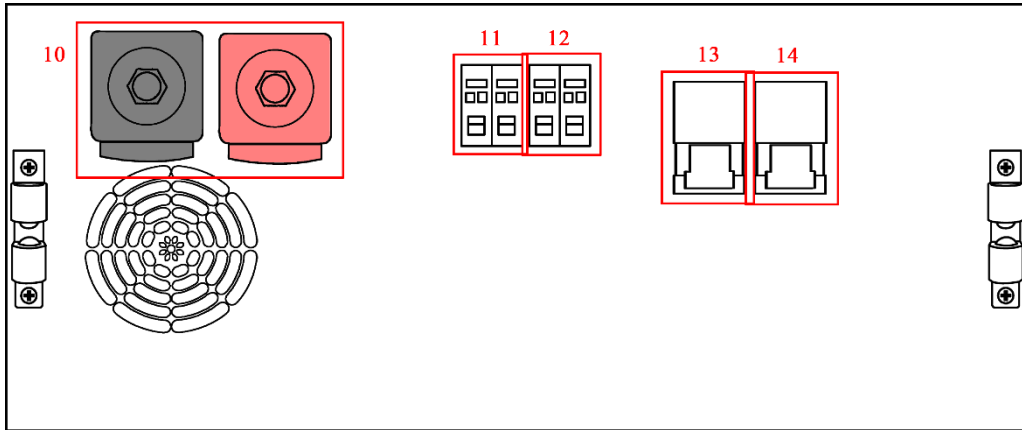

10	Positive and negative terminal posts of the battery pack (red: positive; black: negative)
11	PV input 1 <sup>st</sup> road connection terminal
12	PV input 2 <sup>nd</sup> road connection terminal
13	PV input 1 <sup>st</sup> road air switch
14	PV input 2 <sup>nd</sup> road air switch

**6.3 Battery Pack Connection Area View**

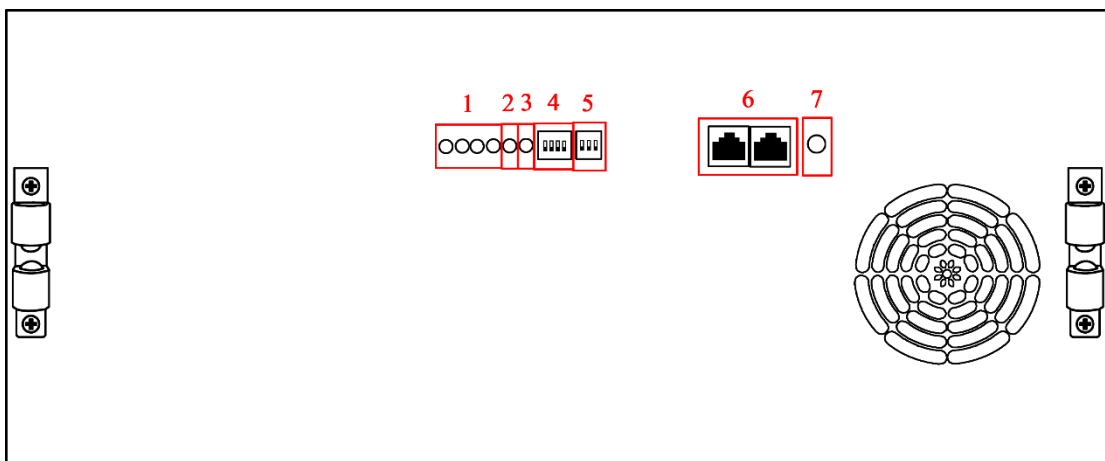

1	SOC of battery pack
2	Run light
3	Fault alarm light
4	Address dip
5	Mode dip (Choose single or multiple battery packs)
6	RS485 communication ports
7	Battery pack ON/OFF button

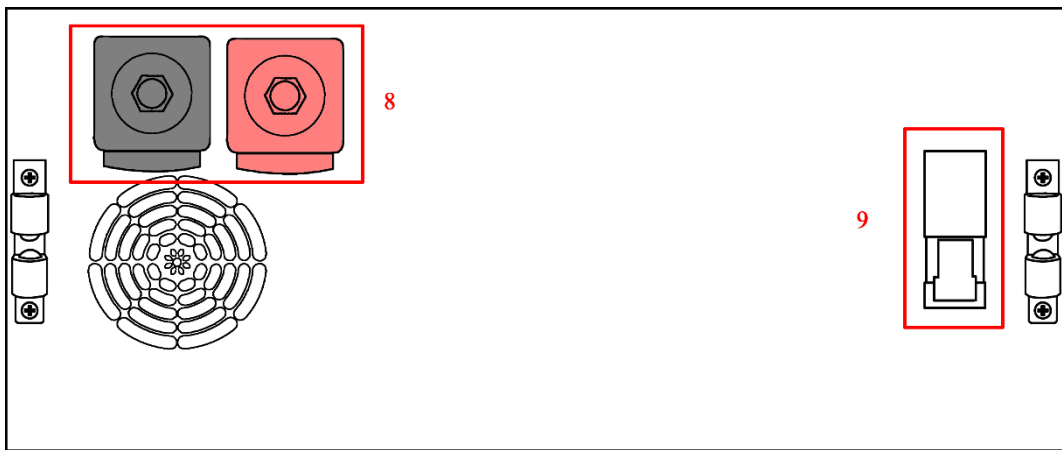

8	Positive and negative terminal posts of the battery pack (red: positive; black: negative)
9	Battery pack air switch

### 6.4 Connection diagram

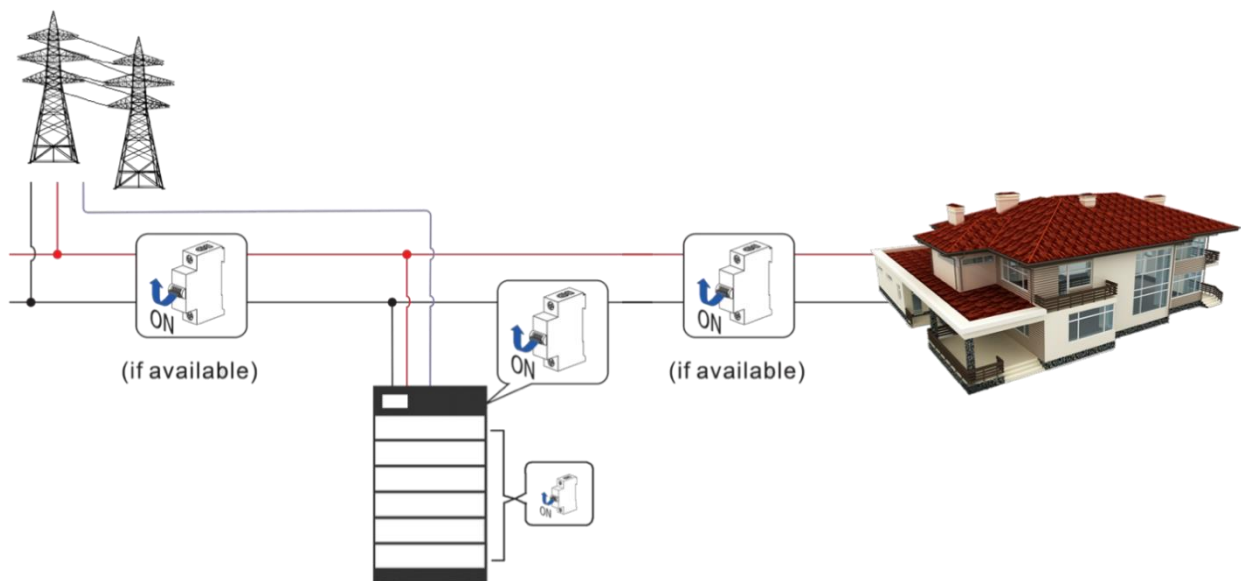

## 6.5 Connecting the Grounding Conductor

### ⚠ QUALIFIED PERSON

Additionally required mounting material (not included in the scope of delivery):

- a) Conductor SC10-5
- b) Grounding cable cross-section: 10 mm<sup>2</sup>

#### Procedure:

1. Remove the covers on both sides of the battery cabinet
2. Make sure all air switches of are off

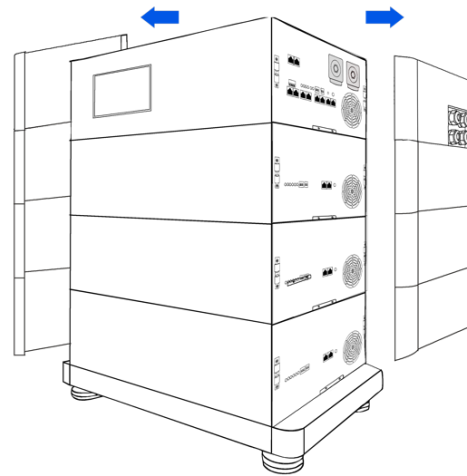

3. Strip the grounding cable and make the length L (on the right drawing) stripped 2~3mm longer than the tube of the conductor (E on the right drawing).

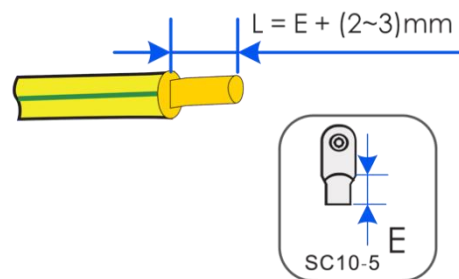

4. Get the heat shrink tubing through the cable and plug the conductor on the cable.
5. Squeeze the tube of the conductor with a crimping pliers.

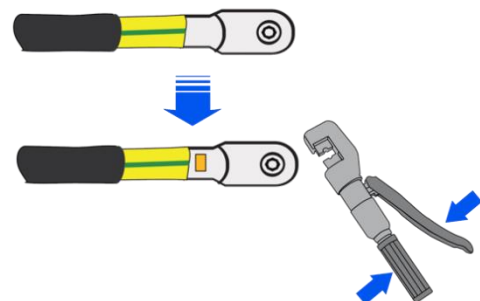

6. Get the heat shrink tubing back to cover the connection part of the cable and the conductor.
7. Blow the heat shrink tubing with hot wind

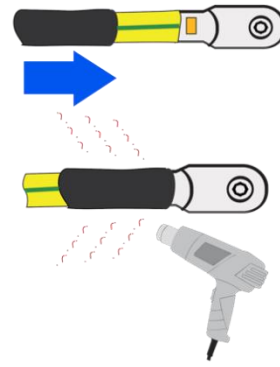

8. Take the original nut on the grounding point off, then fix the PE conductor, using the same nut, with a cylinder screwdriver 8 mm, and tighten it (torque, 4 Nm)

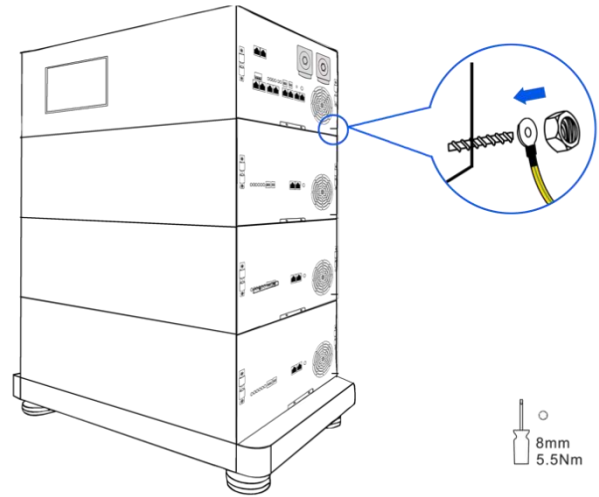

## 6.6 Dial code Information

### 6.6.1 Battery pack address dial code (Blue dip)

Please dial in numerical order, prohibit dialing jump the numerical order.

Notice: 1. The black is dial button.

2. Dial order from top to bottom. (The battery pack at the top of the system is the No. 1)

<p>Address code diagram</p>	Dial code				
	Pack No.	1 (The top battery pack)	2	3	4
	Dial code				
	Pack No.	5	6	7	8

### 6.6.2 Battery pack working mode code (Red dip)

Notice: 1. The black is dial button.

2. The battery pack works in parallel connection (as shown below).

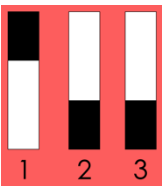
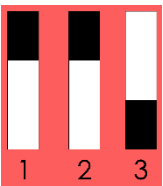
Battery Pack Capacity	Dial code
5kWh Battery Pack	
10kWh Battery Pack	

### 6.7 Communication Cables Connection

Take out the communication cables from the box, insert the CAT5+ cables as shown in the following figures.

#### 6.7.1 Between Battery packs (RS485-2 to RS485-2)

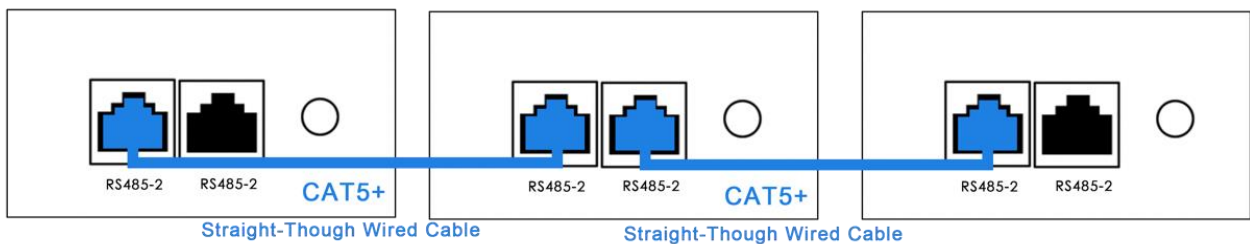

The figure shows 3 battery packs as an example, more battery packs can be deduced by analogy.

#### 6.7.2 Between battery packs and inverter

Notice: The longest communication cable.

## INVERTER

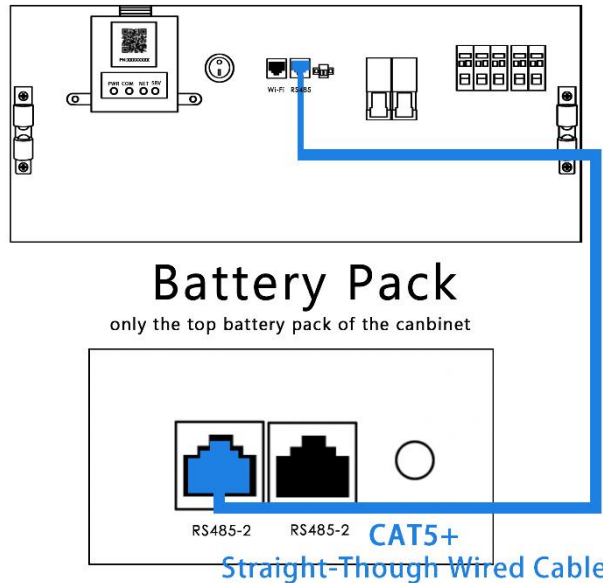

### 6.8 Wiring Connection

#### **⚠ DANGER**

**Danger to life from electric shock due to live cables or conductors at the energy storage system.** The cables connected to the energy storage system may be live. Touching the conductors or the live components leads to lethal electric shocks.

- Do not touch non-insulated cable ends.

**Confirm all the air switches of the system are switched off.**

**Additionally required mounting material (not included in the scope of delivery):**

The following materials is used for AC input connection and AC output connection.

- Five power cables (2 Live line cables; 2 Null Line Cables)

**Cable requirements:**

- Conductor cross-section: 6 to 16 mm<sup>2</sup>. The diameter of the cable should be between 6 mm to 9 mm (at least 8 AWG).
- Insulation stripping length: 16-18 mm
- Maximum cable length: 20 m

**Procedure:**

---

1. Remove the covers on both sides of all Battery packs and inverter
2. Make sure all air switches of are off
3. Take out the positive and negative cables from the box

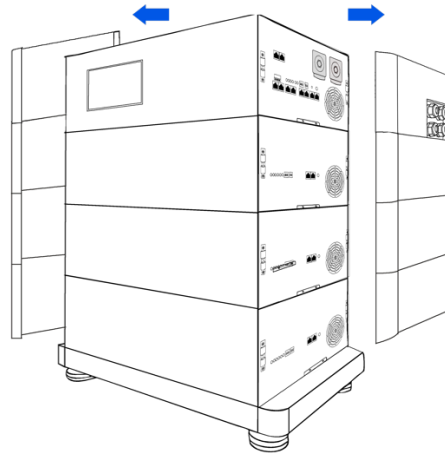

4. Remove the covers and nuts on the positive and negative terminal
5. Put the copper connectors on the terminal, and install the nuts and cover just removed on the terminal

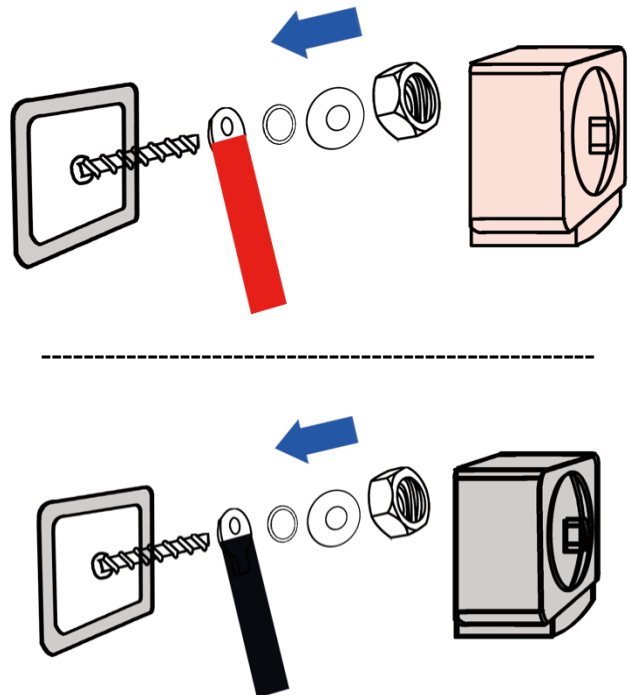

6. Ensure that the terminal points are allocated to the correct cables.
7. Make sure the wires are securely installed.
8. Please refer to the figure for parallel connection



Parallel Connection

9. Strip the AC input and output cables and make the length L (on the right drawing) stripped 1-2cm longer than the tube of the terminals

10. Insert the AC cables into glands of the relative inverter cover

11. Insert the connecting cables into the corresponding connection terminals

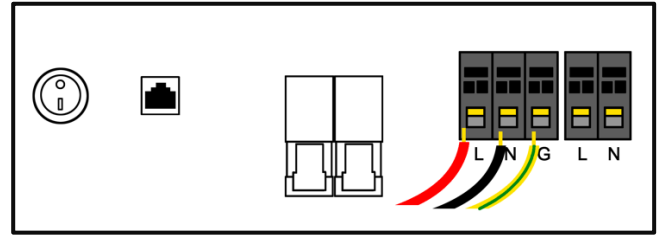

(The picture shows the connection method of AC input, same as the connection method of AC output)

12. Strip the PV positive and negative cables and make the length L (on the right drawing) stripped 1-2cm longer than the tube of the terminal

13. Insert the PV cables into glands of the relative inverter cover

14. Insert the connecting cables into the corresponding connection terminals

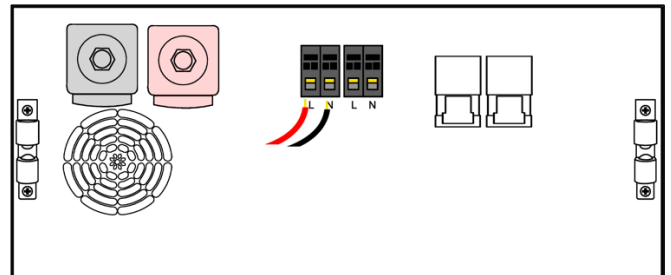

(The picture shows the connection method of 1<sup>st</sup> road PV input, same as 2<sup>nd</sup> road PV input)

## 7. Commission

### ⚠ QUALIFIED PERSON

Requirements:

- 1 All the air switches of the system are switched off.
- 2 The inverter must be correctly mounted.
- 3 All cables must be correctly connected.

Procedure:

1	Make sure all cables are well connected
2	Connect the AC input cable to the utility grid (if any)
3	Make sure the AC output cable is connected. (If the AC output end is not connected to electrical appliances temporarily, please take insulation measures for the AC output connection line to avoid the risk of short and electric shock injury)
4	Check if the dialing codes are correct.

5	Push up air switches of all battery packs to ON
6	Press each ON/OFF button of battery packs from <b>bottom to top</b> . The indicators of the battery packs will light up after the “Beep” sound.
7	Let the connected battery packs stand for about 15 minutes, do not operate the system during this period, because the system will automatically balance the connected battery packs.
8	Turn on the power switch of inverter, the management system will start and run a self-check program. Observe the screen if shows the parameter is correct.
9	Push up AC and PV input air switches to ON (if any)
10	Charge the system to 100% SOC
11	Push up AC output air switch to ON
12	After the system performs a complete charge and discharge cycle, the screen display parameters are accurate and enter the normal workbench.
13	Wi-Fi App devices, please continue with Chapter 8 (Wi Fi App Activation)
14	Refer to Chapter 9 (Installation Completed)

## 8. Wi-Fi App Activation (Wi-Fi App devices)

### Operation steps:

- 1 Turn the Wi-Fi receiver nut clockwise to the corresponding position
- 2 Insert communication cable of Wi-Fi App receiver to the Communication Port (Wi-Fi App port). (Shown in the figure)

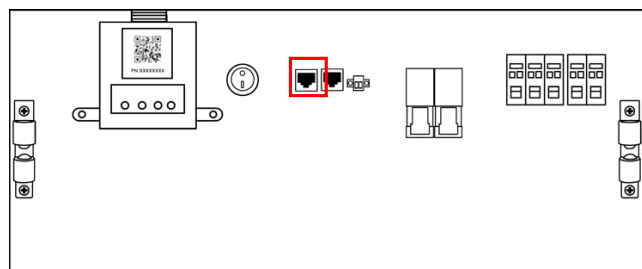
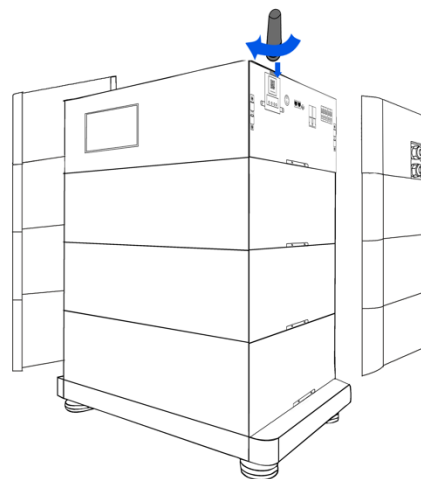

### 3 Wireless Router Connection

#### 3.1 Download the APP

3.1.1 Scan the QR Code from the cover of this guideline.



SmartESS(iOS)



SmartESS(Android)

#### 3.1.2 Download the APP

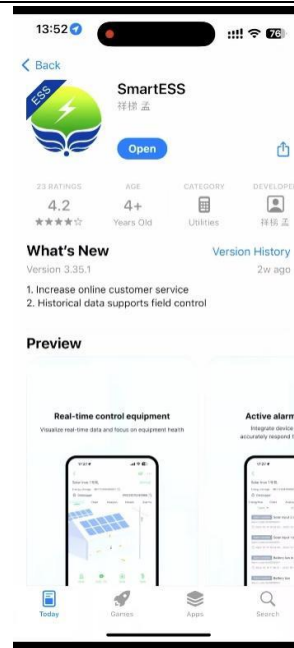

### 3.2 Configuration your System Wi-Fi setting.

3.2.1 Point and click the "Toolbox" and connect to the "Wi-Fi network" plug pro default.

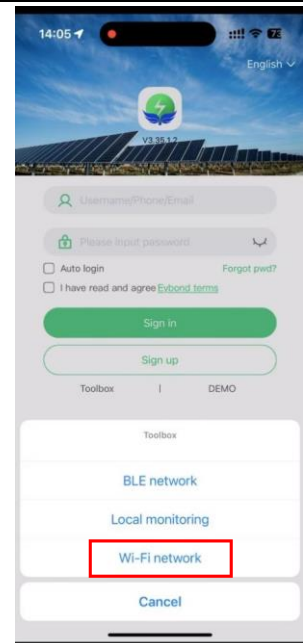
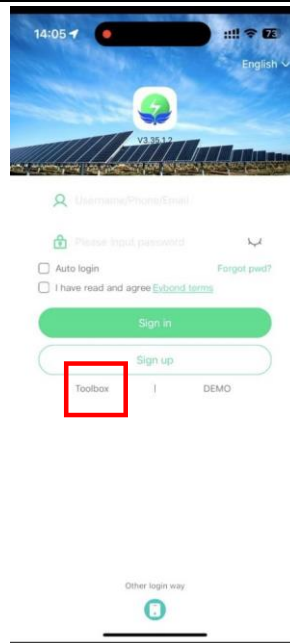

3.2.2 Click the "next" and "Confirm".

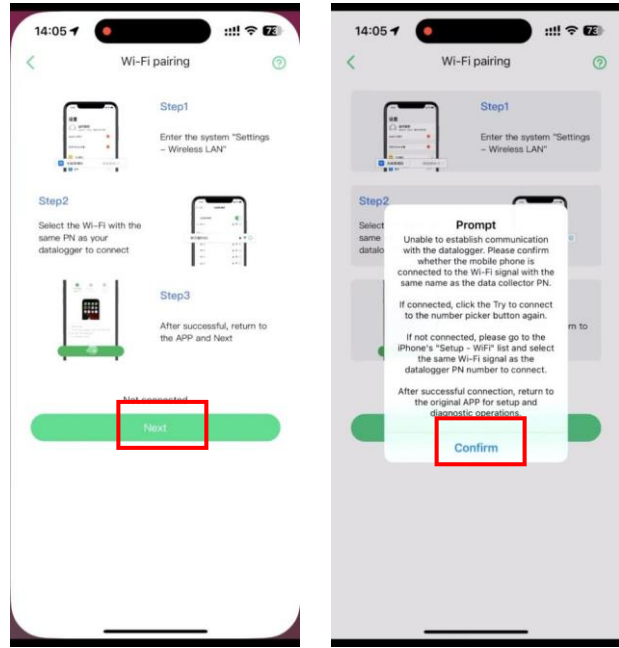

3.2.3 Select the same number of Wi-Fi PlugPro PN to connect on your phone WLAN, (Initial Password:12345678) , click "Join".

PN Code E90000220801282364

Initial Password: 12345678

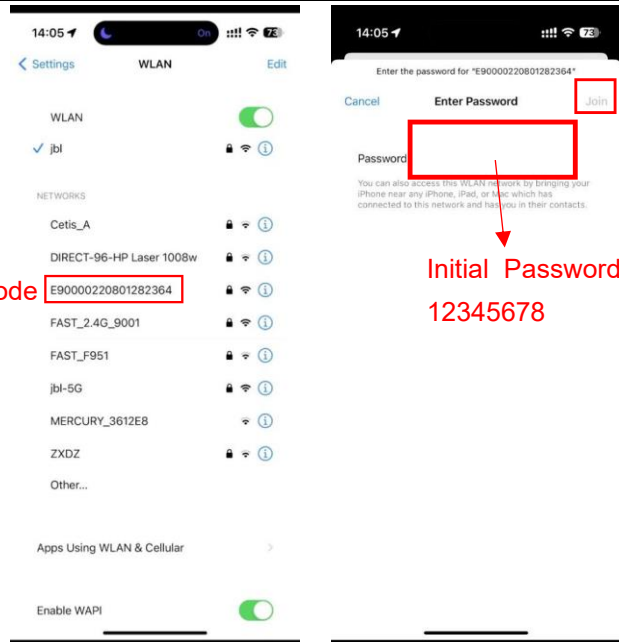

3.2.4 After connecting to the Wi-Fi of the collector and click "next", please connect your Wi-Fi to the router, and input your local passwords of network, and click "Confirm".

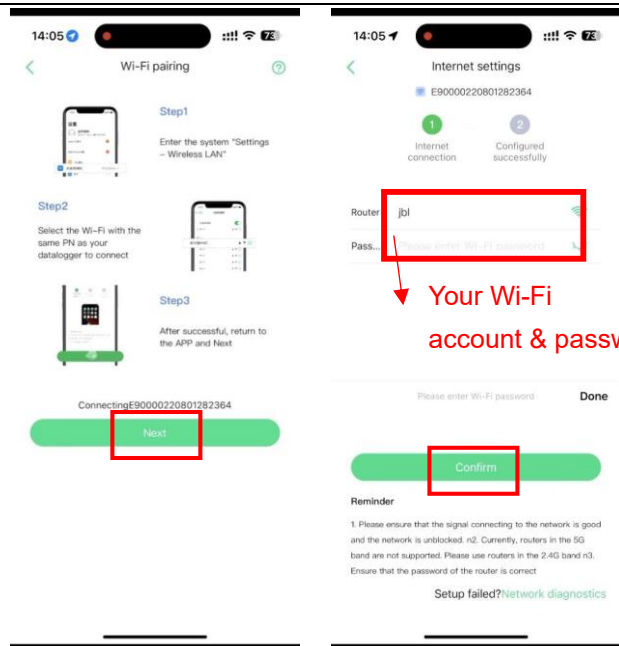

Your Wi-Fi account & password

3.2.5 Waiting for 30s the Internet connection. Configured successfully, please "Back to the homepage"

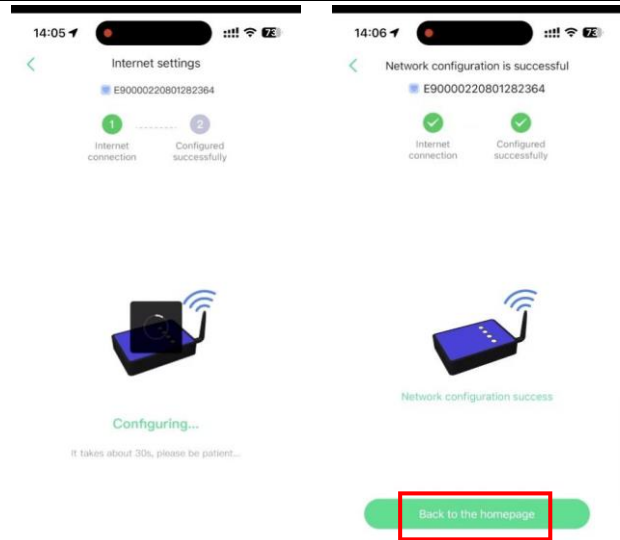

#### 4 Create Account and Datalogger

##### 4.1 Create Account

4.1.1 Click "Sign up " and change PN Wi-Fi to your Wi-Fi.

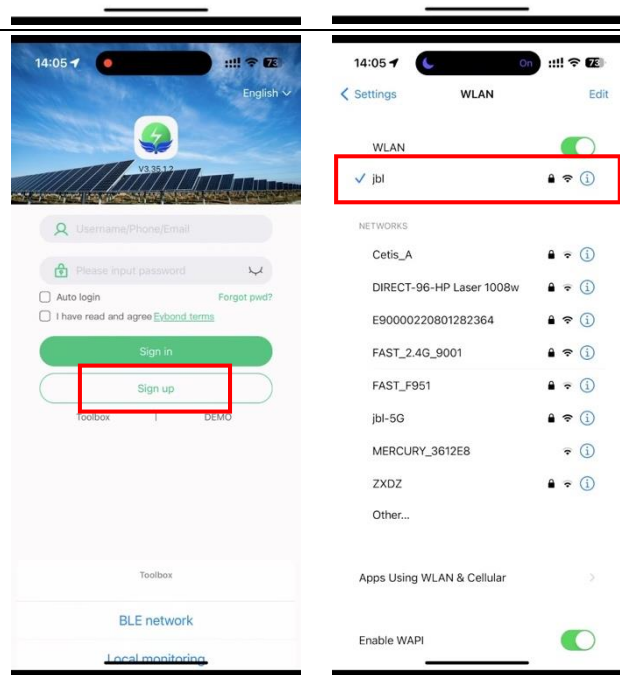

4.1.2 Create your information, Username, E-mail, Verification code(copy the verification code through your E-mail), Account password, Confirm password, click "Sign up now" and "Sign in" .

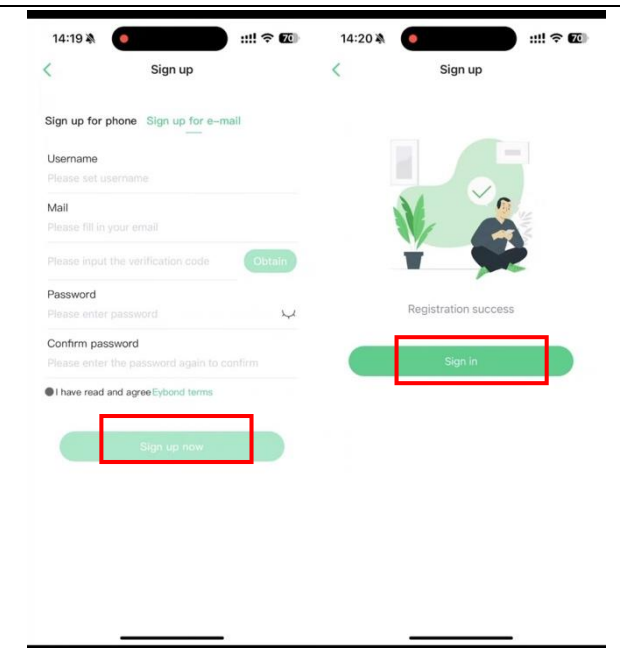

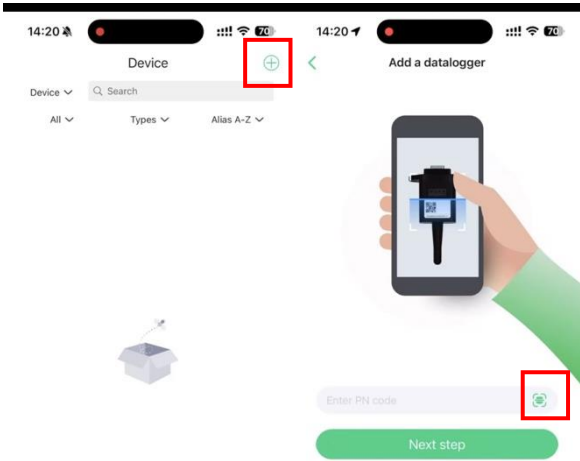

## 4.2 Create Datalogger

4.2.1 Click on the top right corner "+ " to add a datalogger , click on the "camera icon", scan PN QR code, and click "Next step".

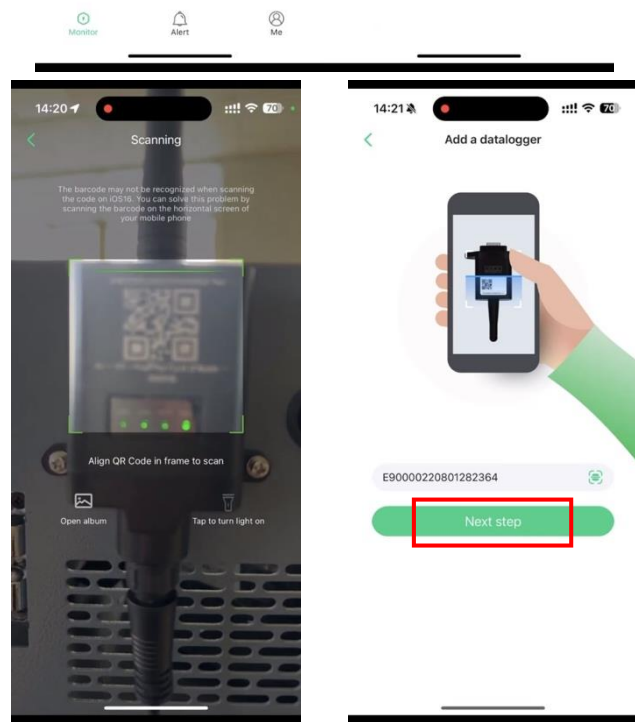

4.2.2 First Select location, then please change your Wi-Fi to PN Wi-Fi, fill in battery capacity, and click "Done".

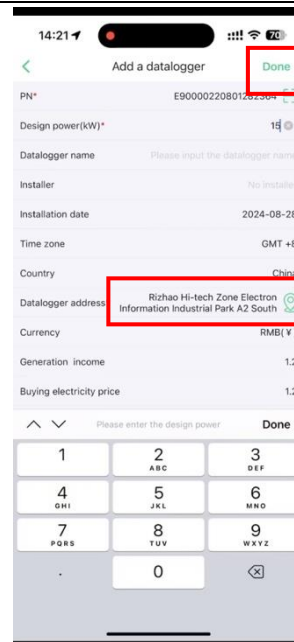

4.2.3 Refresh the page, click on the dropdown list in the upper left corner to change "Device" and " Datalogger ".

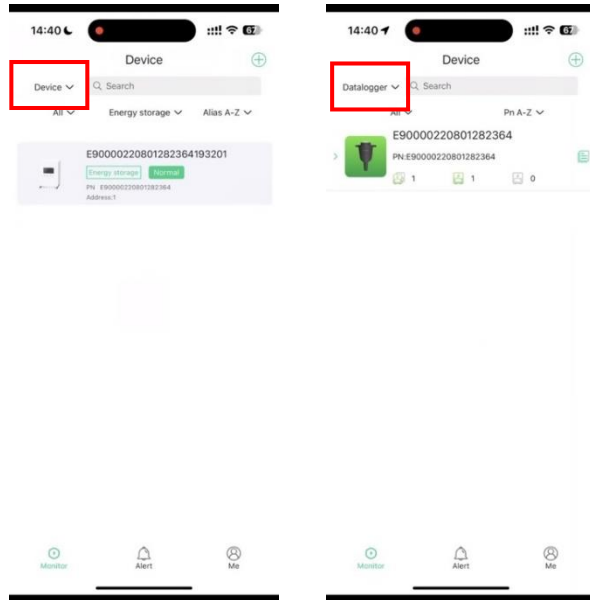

4.2.4 Finish, view the date.



## 9. Close up

### Procedure:

1. Confirm that the connection cable and communication cable are connected correctly
2. Make sure all air switches are on
3. Make sure that all lights work properly
4. Confirm that the screen displays normally and there are no failure prompts
5. Fix on covers removed before

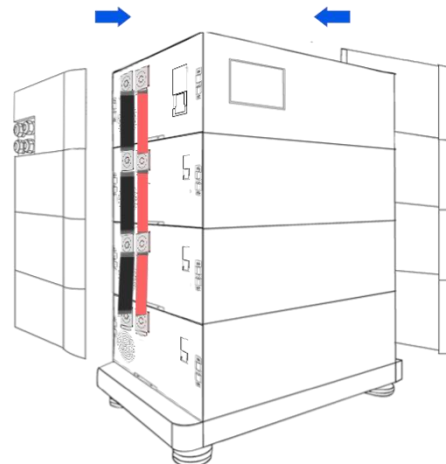

## 10. Decommissioning

### ▲ QUALIFIED PERSON

### ▲ DANGER

**Danger to life from electric shock due to live DC cables or conductors at the energy storage system.** The DC cables connected to the energy storage system may be live. Touching the DC conductors or the live components leads to lethal electric shocks.

- Do not touch non-insulated cable ends.

### ▲ CAUTION

**Risk of injury due to weight of the battery pack.**

Injuries may result if the battery pack is lifted incorrectly or dropped while being transported or installed.

- Transport and lift the battery pack carefully. Take the weight of the battery pack into account.
- Wear suitable personal protective equipment for all work on the energy storage system.

#### Procedure:

1. Switch off the air switch between system and utility grid (if any)
2. Switch off the air switch between system and AC appliances (if any)
3. Disconnect the system from the utility grid and AC appliances
4. Loosen the glands of inverter
5. Remove the covers of system
6. Switch off all air switches of the inverter
7. Push down all air switches of battery packs.
8. When the screen goes off, turn off the inverter switch.
9. Press each ON/OFF button of all battery packs for 3 seconds. After the “beep” sounds, all indicators light off
10. Take off the connection cables.

11. Tighten the nuts on the cable glands on the inverter cover.
12. Remove the screws connecting the inverter, battery packs and base.
13. Take the inverter from battery pack and battery packs from the base.
14. Before lifting the battery pack, ensure that the screws on both sides of them are removed.
15. Remove the hangers (inverter part).
16. If the energy storage system is to be stored or shipped, pack the system. Use the original packaging or packaging that is suitable for the weight and dimensions of the system.
17. Dispose of the energy storage system in accordance with the locally applicable battery disposal regulations.

## 11. Extension

### ⚠ QUALIFIED PERSON

#### ⚠ DANGER

**Danger to life from electric shock due to live positive and negative terminals or conductors at the battery pack.** The positive and negative terminal connected to the battery pack may be live. Touching the terminals or the live components leads to lethal electric shocks.

- Do not touch non-insulated terminal ends.

#### ⚠ CAUTION

**Risk of injury due to weight of the battery pack.**

Injuries may result if the battery pack is lifted incorrectly or dropped while being transported or installed.

- Transport and lift the battery pack carefully. Take the weight of the battery pack into account.
- Wear suitable personal protective equipment for all work on the energy storage system.

Before that, it is necessary to check whether the new battery pack is operating normally as follows:

1. Turn on the air switch of the battery pack;
2. Press the battery pack ON/OFF button;
3. Measure whether the battery pack voltage is within the normal working voltage range (51V~53.2V).

**Procedure:**

1. Check the parameters of the existing system through the screen.
2. Switch off all battery packs.
3. Shut off the inverter.
4. Take the inverter off.
5. Add the new pack on top of other battery packs.
6. Put inverter back on top of the new battery pack.
7. Connect the new battery pack to the energy storage system. (Check connections and communication).
8. Configure the dial code of Single or multiple mode and address code (part6.6).
9. Switch on the energy storage system. (See more information Chapter 6)
10. Start the inverter.

**Notice: The newly added battery pack may have inaccurate SOC measurement. The system can accurately detect the SOC only after the overall energy storage system has undergone a working cycle. The number of battery packs in this system is 1 to 8.**

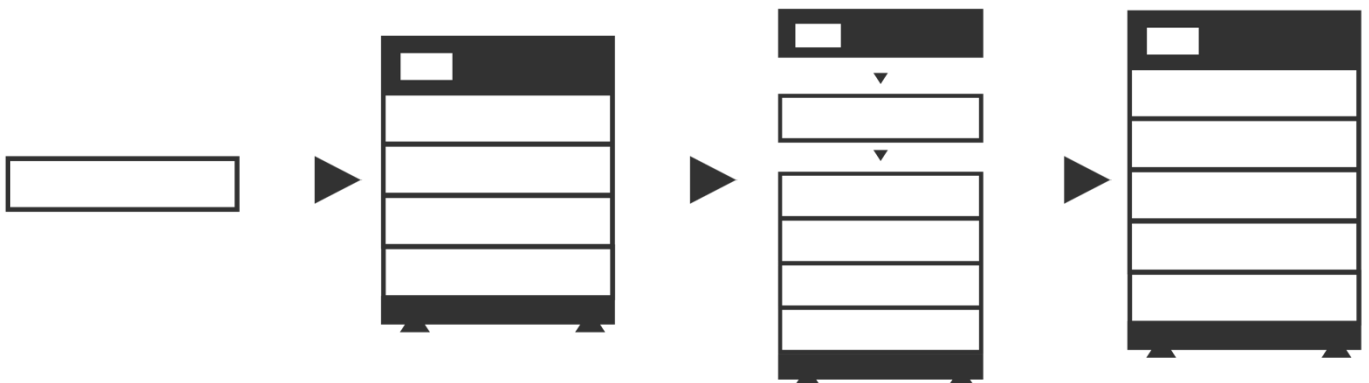

## 12. Troubleshooting

Please also see the CONCENPOWER Service Guideline and Checklist for troubleshooting. The latest version is available at our website [www.concenpower.com](http://www.concenpower.com).

### 12.1 Energy storage system Behavior under Fault Conditions

#### Error shows on inverter screen

The type of fault that has occurred is shown on the display of the energy storage system. Any system shutdown caused by any failure will cause the device to sound an alarm. If you hear an alarm sound, please confirm the type of failure in time, shut down the system and contact after-sales service.

The clicking sound when the system is turned on is not a malfunction.

**NOTE**

**Damage to the energy storage system due to under voltages**

- If the battery is installed, it should be set into operation within a month, or checked regularly, otherwise there might be damage to the batteries.

**12.2 Inverter cannot Detect Battery Information**

When the energy storage system is connected to the inverter, the inverter cannot detect the battery information, the possible reason is the communication line between the inverter and the energy storage system is not connected properly.

**12.3 Error Event**

No.	Name	Solution
1	Overpower protection (OPP)	The problem may be caused by discharging the energy storage system. Turn off the charging of the system, wait for the system voltage to return to normal, and then the protection will be automatically released. Test the voltage of each battery pack (Service Guideline and Checklist Part 4.2). Please refer to Chapter 15 for the normal operating voltage of the battery pack.
2	Low battery voltage protection (UVP)	Shut down the system quickly to avoid further discharge. Check whether the system can shut down normally (by pressing the inverter ON/OFF button for 5s). - If the system cannot shut down normally, lift the inverter. Avoid further discharge of the battery, by searching the problem while the battery is completely off / inverter is lifted. Do not turn on the battery before making sure the inverter should be able to charge the battery. Test the voltage of each battery pack (Service Guideline and Checklist Part 4.2). Please refer to Chapter 15 for the normal operating voltage of the battery pack.
3	Over temperature protection (OTP)	Shut down the system quickly to avoid further operating. Wait for the system temperature to return to normal and the protection will be released automatically

4	Under temperature protection (UTP)	The ambient temperature (more information on parameter sheet) of the system is too low, please adjust the ambient temperature.
---	------------------------------------	--

### 13. Maintenance and Storage

#### Cleaning

It is recommended that the energy storage system be cleaned periodically. If the enclosure is dirty, please use a soft, dry brush or a dust collector to remove the dust. Liquids such as solvents, abrasives, or corrosive liquids should not be used to clean the enclosure.

#### Maintenance

The battery pack should be stored in an environment with a temperature range between -10°C ~ +50°C, and charged regularly according to the table below with no more than 0.5 C (A C-rate is a measure of the rate at which a battery is discharged relative to its maximum capacity.) to the SOC of 30% after a long time of storage.

Storage environment temperature	Relative humidity of the storage environment	Storage time	SOC
Below -10°C	/	Not allowed	/
-10~25°C	5%~70%	≤ 12 months	25%≤SOC≤60%
25~35°C	5%~70%	≤ 6 months	25%≤SOC≤60%
35~50°C	5%~70%	≤ 3 months	25%≤SOC≤60%
Above 50°C	/	Not allowed	/

### NOTE

#### Damage to the system due to under voltages

- Charge the over-discharged system within seven days when the temperature is above 25°C.
- Charge the over-discharged system within fifteen days when the temperature is below 25° C.





## 14. Disposal of Energy storage system





Disposal of the system must comply with the local applicable disposal regulations for electronic waste and used batteries.

- Do not dispose of the energy storage system with your household waste.
- Avoid exposing the batteries to high temperatures or direct sunlight.
- Avoid exposing the batteries to high humidity or corrosive atmospheres.
- For more information or arrange a collection please contact CONCENPOWER Service Partner (see contact details at the bottom of this document).

## 15. Technical Data





### 15.1 2.5kWh Battery Pack

<b>1-4 Battery Pack Energy storage system</b>    				
Battery Package	2.5kWh, 51.2V, 26Kg, 550*300*180mm			
Number of Packages	1	2	3	4
Usable Capacity	2.5kWh	5kWh	7.5kWh	10kWh
Max. Output Current	100A	100A	100A	100A
Peak Output Current	150A	150A	150A	150A
Nominal Voltage	51.2V	51.2V	51.2V	51.2V
Operating Voltage	40~58.4V	40~58.4V	40~58.4V	40~58.4V
Size (L/W/H mm)	550*300*480	550*300*660	550*300*840	550*300*1020
Weight (Kg)	58	84	110	136
Operating Temperature	-10°C~50°C			
Charging Temperature	Above 0°C			
Battery Type	Lithium iron phosphate Battery (LiFePO4)			
Communication	RS485, CAN			
Enclose Protection Rating	IP55			
Life Cycle	3000Times			

<b>5-8 Battery Pack</b> <b>Energy storage system</b>				
				
Battery Package	2.5kWh, 51.2V, 26Kg, 550*300*180mm			
Number of Packages	5	6	7	8
Usable Capacity	12.5kWh	15kWh	17.5kWh	20kWh
Max. Output Current	100A	100A	100A	100A
Peak Output Current	150A	150A	150A	150A
Nominal Voltage	51.2V	51.2V	51.2V	51.2V
Operating Voltage	40~58.4V	40~58.4V	40~58.4V	40~58.4V
Size (L/W/H mm)	550*300*1200	550*300*1380	550*300*1560	550*300*1740
Weight (Kg)	162	188	214	240
Operating Temperature	-10°C~50°C			
Charging Temperature	Above 0°C			
Battery Type	Lithium iron phosphate Battery (LiFePO4)			
Communication	RS485, CAN			
Enclose Protection Rating	IP55			
Life Cycle	3000Times			

<b>INVERTER</b>	
Inverter Type	Power Frequency Inverter
Rate Output Power	3000W
AC Input/Output Voltage	160-260 V / 80-130 V
AC Input/Output Frequency	50 / 60 Hz
Solar Controller	Build-in MPPT *1 Road
Solar Input Current	MAX. 60A *1
Solar Input Voltage	60-180 V

15.2 5.12kWh Battery Pack

<b>1-4 Battery Pack Energy storage system</b>    				
Battery Package	5.12kWh, 51.2V, 49Kg, 700*435*190mm			
Number of Packages	1	2	3	4
Usable Capacity	5.12kWh	10.24kWh	15.36kWh	20.48kWh
Max. Output Current	100A	100A	100A	100A
Peak Output Current	150A	150A	150A	150A
Nominal Voltage	51.2V	51.2V	51.2V	51.2V
Operating Voltage	40~58.4V	40~58.4V	40~58.4V	40~58.4V
Size (L/W/H mm)	700*435*490	700*435*680	700*435*870	700*435*1060
Weight (Kg)	95	143	192	240
Operating Temperature	-10°C~50°C			
Charging Temperature	Above 0°C			
Battery Type	Lithium iron phosphate Battery (LiFePO4)			
Communication	RS485, CAN			
Enclose Protection Rating	IP55			
Life Cycle	3000Times			

**5-8 Battery Pack  
Energy storage system**

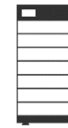
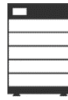





Battery Package	5.12kWh, 51.2V, 49Kg, 700*435*190mm			
Number of Packages	5	6	7	8
Usable Capacity	25.6kWh	30.72kWh	35.84kWh	40.96kWh
Max. Output Current	100A	100A	100A	100A
Peak Output Current	150A	150A	150A	150A
Nominal Voltage	51.2V	51.2V	51.2V	51.2V
Operating Voltage	40~58.4V	40~58.4V	40~58.4V	40~58.4V
Size (L/W/H mm)	700*435*1250	700*435*1440	700*435*1630	700*435*1820
Weight (Kg)	289	338	387	436
Operating Temperature	-10°C~50°C			
Charging Temperature	Above 0°C			
Battery Type	Lithium iron phosphate Battery (LiFePO4)			
Communication	RS485, CAN			
Enclose Protection Rating	IP55			
Life Cycle	3000Times			

**INVERTER**

Inverter Type	Power Frequency Inverter
Rate Output Power	5KW / 10KW
AC Input/Output Voltage	160-260 V / 80-130 V
AC Input/Output Frequency	50 / 60 Hz
Solar Controller	Build-in MPPT *2 Road
Solar Input Current	MAX. 80A *2
Solar Input Voltage	60-180 V

15.3 10.24kWh Battery Pack

<b>1-4 Battery Pack Energy storage system</b>    				
Battery Package	10.24kWh, 51.2V, 83Kg, 700*435*265mm			
Number of Packages	1	2	3	4
Usable Capacity	10kWh	20kWh	30kWh	40kWh
Max. Output Current	200A	200A	200A	200A
Peak Output Current	250A	250A	250A	250A
Nominal Voltage	51.2V	51.2V	51.2V	51.2V
Operating Voltage	40~58.4V	40~58.4V	40~58.4V	40~58.4V
Size (L/W/H mm)	700*435*565	700*435*830	700*435*1095	700*435*1360
Weight (Kg)	141	224	307	390
Operating Temperature	-10°C~50°C			
Charging Temperature	Above 0°C			
Battery Type	Lithium iron phosphate Battery (LiFePO4)			
Communication	RS485, CAN			
Enclose Protection Rating	IP55			
Life Cycle	3000Times			

<b>5-8 Battery Pack Energy storage system</b>					
		10.24kWh, 51.2V, 83Kg, 700*435*265mm			
Number of Packages	5	6	7	8	
Usable Capacity	50kWh	60kWh	70kWh	80kWh	
Max. Output Current	200A	200A	200A	200A	
Peak Output Current	250A	250A	250A	250A	
Nominal Voltage	51.2V	51.2V	51.2V	51.2V	
Operating Voltage	40~58.4V	40~58.4V	40~58.4V	40~58.4V	
Size (L/W/H mm)	700*435*1625	700*435*1890	700*435*2115	700*435*2420	
Weight (Kg)	473	556	639	722	
Operating Temperature	-10°C~50°C				
Charging Temperature	Above 0°C				
Battery Type	Lithium iron phosphate Battery (LiFePO4)				
Communication	RS485, CAN				
Enclose Protection Rating	IP55				
Life Cycle	3000Times				

<b>INVERTER</b>	
Inverter Type	Power Frequency Inverter
Rate Output Power	5KW / 10KW
AC Input/Output Voltage	160-260 V / 80-130 V
AC Input/Output Frequency	50 / 60 Hz
Solar Controller	Build-in MPPT *2 Road
Solar Input Current	MAX. 80A *2
Solar Input Voltage	60-180 V

## 16. Contact Information

**Notice:** Please also see the CONCENPOWER High voltage system Service Guideline and Checklist Service Guideline and Checklist for troubleshooting. The latest version is available at our website [www.concenpower.com](http://www.concenpower.com).

<b>CONCENPOWER Global Service</b>	
Official services link	Social media link
<a href="http://www.concenpower.com">www.concenpower.com</a>	<a href="https://www.facebook.com/CONCENPOWER">https:// www.facebook.com/ CONCENPOWER</a>
E-mail: <a href="mailto:techsupport.yang@concenpower.com">techsupport.yang@concenpower.com</a> <a href="mailto:nevaehdu@concenpower.com">nevaehdu@concenpower.com</a>	<a href="https://twitter.com/CONCENPOWER">https://twitter.com/ CONCENPOWER</a>
<a href="http://www.concenpower.com">www.concenpower.com</a>	<a href="https://www.linkedin.com/company/concenpower">https://www.linkedin.com/company/concenpower</a>
Address: A2-A, Electricity Information Industrial Park, High-tech 7 Rd., Gaoxin District, Rizhao, Shandong, China (Mainland)	